

Instruction Manual: 1900950

Machine P/N: 1000950 / 1001950US / 1000950EU

**ColdBRU**

# Contents

1. Box Contents.....	3
- Compatible with.....	3
2. Information.....	4
- Introduction.....	4
- Safety.....	4
- Electrical Installation Procedure.....	5
- Plumbing Installation Procedure.....	5
- Backflow Prevention.....	5
- Maintenance.....	5
- Hazards.....	6
3. Installation.....	7
- Connecting the ColdBRU to water.....	7
- Connecting the ColdBRU to power.....	7
4. Setup.....	8
- Calibrate the machine.....	8
- Create your own recipe.....	8
- Prepare ColdBRU for Brewing.....	9
5. Brewing with ColdBRU.....	10
- Method 1: Create new brew.....	10-12
- Method 2: Record brew.....	13-14
- Accessing saved brew.....	15-16
6. After Brew.....	17
7. Cleaning.....	18
8. Adjust recipe/Troubleshooting.....	19

# Box Contents

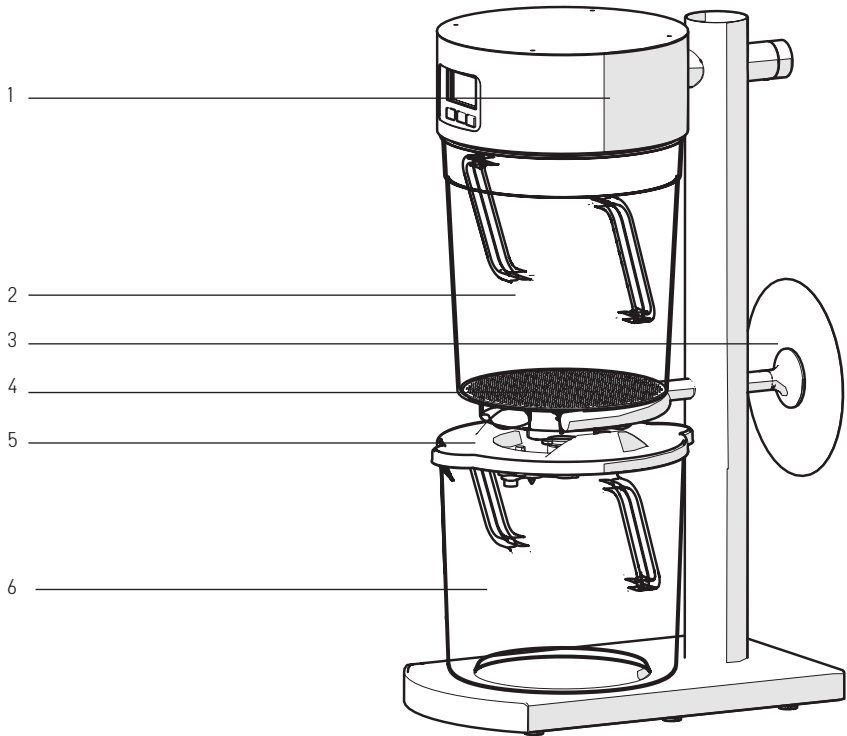

- 1.** ColdBRU machine 1000950
- 2.** Brew Chamber 1801489
- 3.** ColdBRU Tamp 2200638
- 4.** Filter Plate 2200635
- 5.** Container Lid 1801487
- 6.** 7.67 Litre (2.03 US Gallon) Container 1801486

## NOT LABELLED

- 1x C13 IEC power cable
- 1x Inlet hose
- 1x Instruction manual 1900950

# Information

## Introduction

The information provided in this manual is intended to assist in the installation and maintenance of the appliance. Please read the instructions carefully to prevent accidents and ensure an efficient installation. This manual is not a substitute for any safety instructions or technical data affixed to the machine or its packaging. All information in this manual is current at the time of publication and is subject to change without notice. The company accepts no responsibility for any damage or injury caused by incorrect or unreasonable installation and operation.

## Safety

When using electrical appliances, basic safety precautions should always be followed to prevent the risk of fire, electric shock, burns, or other injuries or damages.

- Read all operating and safety instructions carefully.
- This appliance is suitable for indoor use only.
- This appliance must be placed/installed on a horizontal flat stable surface.
- The ambient temperatures this appliance should operate within are 5 °C – 35 °C (41°F–95°F).
- Do not store the appliance in ambient temperature lower than 5 °C (41°F).
- The hose supplied with the product is non-toxic food quality. However, a hose is not a permanent connection. It is, therefore, advisable to switch off and close the stopcock valve when the appliance is not in use, e.g. overnight etc.
- If a non-fixed water connection is implemented, use only the water hose provided with the appliance, alternatively, if a fixed water connection is used it must be implemented using a non-detachable water hose.
- The utmost care has been taken in the manufacture and testing of this appliance. Failure to install, maintain and / or operate this machine according to the manufacturer's instructions may result in conditions that can cause injury or damage to property. If in any doubt about the serviceability of the machine always contact the manufacturer or your own supplier for advice.
- This appliance is not intended for use by persons (including children) with reduced physical, sensory, or mental capabilities, or lack of experience and knowledge, unless they have been given supervision or instruction concerning use of the machine by a person responsible for their safety.
- Children should be supervised to ensure that they do not play with the appliance.
- In the event where any wires are damaged, such wires can only be replaced by qualified service technicians.
- CAUTION – Risk of fire and electric shock. Only to be used with manufacturer's specified power cord set.
- This appliance should not be installed in an area where a water jet could be used to clean it.
- Access to the service area of the appliance is restricted to persons having knowledge and practical experience of the appliance and the relevant safety and hygiene requirements.

# Information

## **Electrical Installation Procedure**

When installing the appliance, always observe the local regulations and standards. The appliance is supplied with a moulded power cord. A suitable mains power supply socket should be available within easy access of the appliance so that it can be disconnected easily after install.

## **Plumbing Installation Procedure**

- Ensure that the equipment is installed according to local plumbing & water regulations.

Mains water pressure required (limits): 14.5 – 145psi (0.1 – 1.1 MPa).

- Fit a stop valve on a cold water line and attach a 9/16–24 UNEF (3/8 Compression Threads).
- Turn on the water to flush any impurities, dust etc from the inlet hose and water pipe. Allow several litres through. Especially for new installations.
- Connect the hose to the inlet valve of the appliance.
- Turn on water and check for leaks.

## **Backflow Prevention**

This equipment must be installed with adequate backflow protection to comply with all applicable federal, state and local codes.

## **Maintenance**

This appliance has been designed to give many years of trouble free service. The only regular maintenance required is regular wipe down of body and spray head as well as washing of containers.

# Information

## Hazards



### CAUTION

#### SANITISATION

Before sanitising the equipment, carefully read the instructions given by the sanitisation product manufacturer and put on all the necessary personal protective equipment (gloves, masks, etc.).

Ensure that the premises are well ventilated.

The sanitisation operations should only be carried out by specialised technical



### DANGER

#### ELECTRICAL MAINS

Always disconnect the equipment from the electricity supply before doing any work on it, to prevent damage and health hazards.



### CAUTION

#### ELECTRICAL REQUIREMENTS

The electrical circuit must be correctly earthed and connected by means of a suitable differential safety breaker.



### CAUTION

#### ELECTRIC POWER SUPPLY

Do not connect or disconnect the machine from the socket with wet hands.

Insert the plug into the wall socket firmly.

Do not pull on the supply cable in order to remove the plug from the socket.



### CAUTION

#### REPLACEMENT OF THE POWER CABLE

If the power cable is damaged, it must be replaced by the manufacturer or their assistance

service or a similarly qualified person in order to prevent any possible risk.



### WARNING

#### MALFUNCTION

If smoke, unusual smells or strange noises are emitted from the machine, disconnect it immediately from the socket and contact the local retailer or technical service assistance.

Use of the machine in these conditions could cause fires or electric shocks.



### ATTENTION

If the equipment is installed in a kitchen, European Standard EN 60335-2/75 specifies that it must be connected to an equipotential circuit via a wire with section between 2,5 and 10 mm<sup>2</sup>. This connection must be carried-out by a skilled technician, in compliance with the regulation in force in the country of use.



### WARNING

#### WATER SUPPLY

Connect the water dispenser exclusively to a line of drinkable water supply.



### WARNING

#### WATER SUPPLY

In order to avoid accidental flooding due to losses that may occur on the water supply line, external or internal device it is necessary to install the appropriate anti-flooding valve "WATER BLOCK" (not included in the unit) .

# Installation

## 1. Connecting the ColdBRU to water

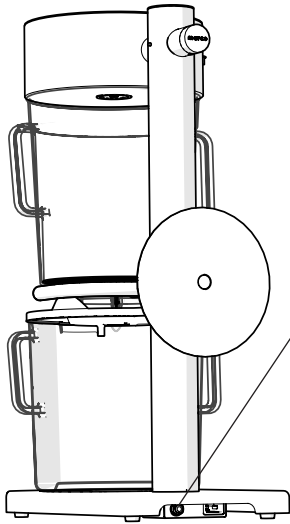

1. Push 1/4" hose into water in push fitting

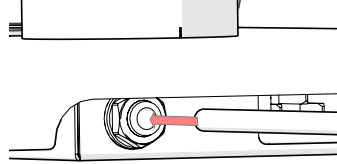

2. Connect 3/4" threaded fitting to water mains

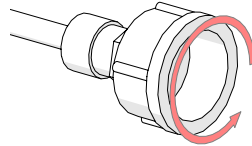

## 2. Connecting the ColdBRU to power

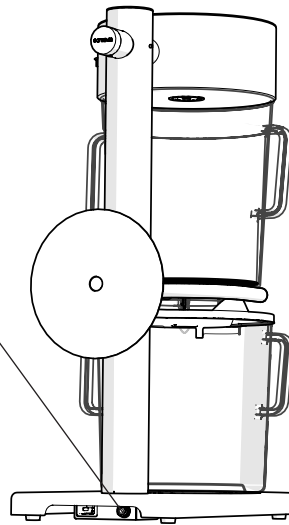
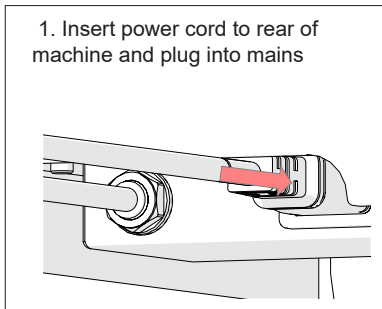

# Setup

Calibrate the machine. (Only necessary on initial plug in of machine or if water pressure changes).

Right after plug in, settings icon will appear, press all three buttons at once. if you miss this menu, unplug and try again.

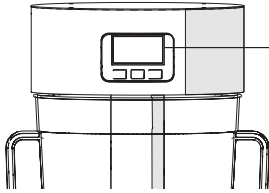

Position 7.67L container under sprayhead to catch dispensed water



Right after plug in, settings icon will appear, press all three buttons at once.

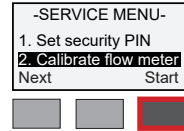

Scroll to "calibrate flow meter" option on the menu and press "start"



Weigh dispensed water

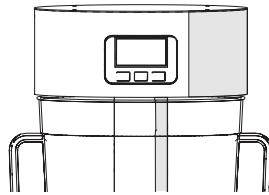

Input water weight into machine. The machine is now calibrated.

## Create your own recipe

**Note:** the **maximum** dispense of the ColdBRU is **10.5 Litres/2.75 Gallons (US)**. To avoid overfilling the ColdBru, we suggest starting with a medium sized brew and adjusting based on your results. If you achieve less than this, you should repeat the brew, grinding finer, or increasing the coffee dose to create a deeper bed.

### Suggested starting point for New recipe (medium capacity brew) for ColdBru:

- 800g medium ground coffee.
- 5000ml/1.3 Gallons (US) water.
- 02:00hr Brew Time (this refers to the water delivery time, overall contact and drain time will vary).
- Initial pulse should be set to 60% total volume, ideally this will create a head of brew water above the coffee bed. Initial pulse value can be increased if necessary.



# Prepare ColdBru for brewing

1.

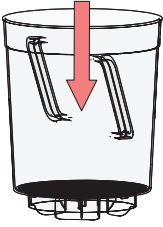

Insert metal filter

2.

Weigh amount of coffee according to recipe on screen

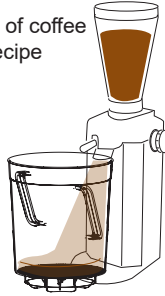

Weigh and grind into brew chamber according to recommended grind size

3.

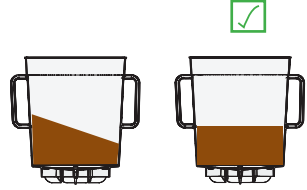

Level coffee bed. Do not shake/tap to level as this will force coffee through the filter

4.

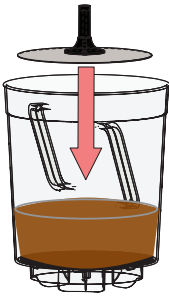

Tamp coffee bed using provided tamp, flattening the ground coffee

5.

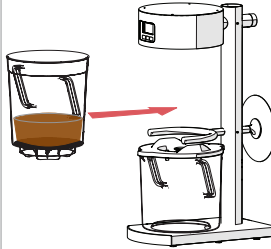

Insert brew chamber into machine

6.

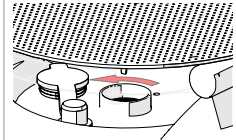

Ensure container is open and lined up correctly with nozzle of brew chamber

# Brewing with ColdBru

## Method 1: Create new brew

**Note:** The Preset Brew option dispenses the desired water volume over 6 separate phases. Each phase consists of a water dispense time and a drain time. The amount of water dispensed in the 1st phase is dictated by the user as a percentage of the entire volume of water. The remaining water dispensed is distributed in equal parts across the remaining 5 phases.

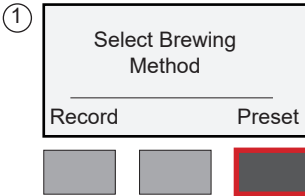

Select **“Preset”** mode.



If you want to create a brew different to those saved in memory select **“New”**.

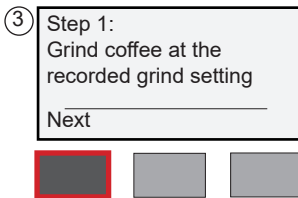

Follow on-screen prompt.

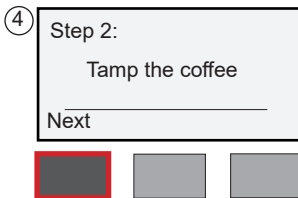

Follow on-screen prompt.

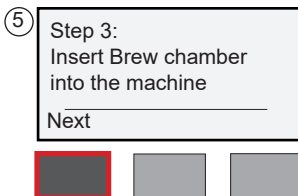

Follow on-screen prompt.

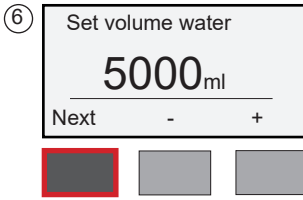

Press +/- to dial in required volume of water for this brew and press **“Next”** when done.

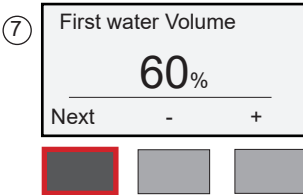

Use the +/- buttons to dial in the % of the total water that will be dispensed in the first pulse.

For medium brews (800g coffee + 5ltrs of water) we would not recommend going over 60% in case of overflowing. For smaller brews this can be exceeded.

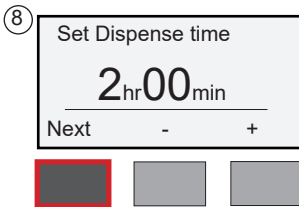

Use the +/- buttons to dial in the dispense time.

Note: This is not the full brew time, brew time may require additional time at the end to ensure all water has filtered through the coffee.

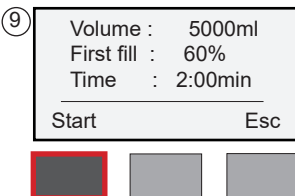

Review the brew settings.

Pressing **“Start”** will start water dispense.

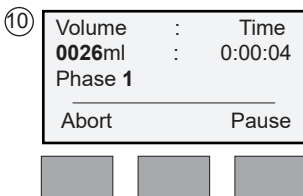

During the dispense phase, the brew can be paused or aborted.

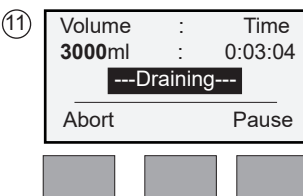

After the machine has dispensed the designated amount of water for the first phase, it will allow drain time before moving onto the next phase. This cycle will continue until all 6 phases are complete.

12

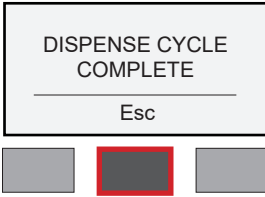

Once all phases of the brew have been completed a message will appear on screen informing the user. Press "**Esc**" to move to next screen.

Method 2: Record brew

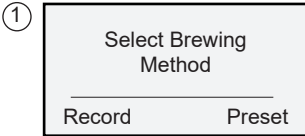

Select "**Record**".

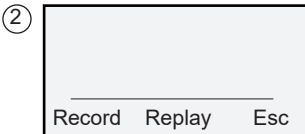

Select "**Record**" mode.

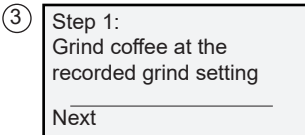

Follow on-screen prompt.

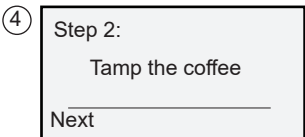

Follow on-screen prompt.

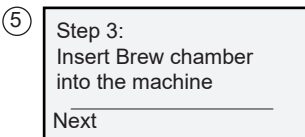

Follow on-screen prompt.

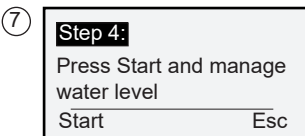

Follow on-screen prompt.

Pressing "**Start**" will start water dispense.

Pressing "**Esc**" will give you the option to exit the brew.



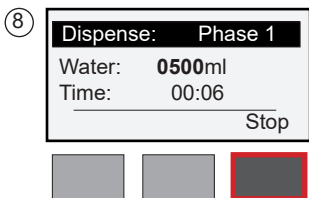

The screen will display the amount of water dispensed and the elapsed time.

Press **“Stop”** when satisfied with water volume (through visual confirmation of water in the brew chamber or volume displayed on-screen). Pressing **“Stop”** will stop the water dispense and start the filter phase timer.

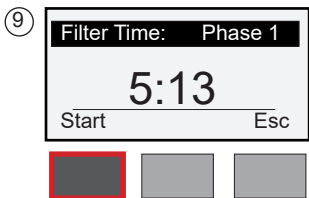

Filter time begins. This time represents elapsed time that water has been filtering through the coffee and includes dispense time. When satisfied that sufficient water has filtered through the coffee, press **“Start”** to commence second water dispense. This cycle continues through a **maximum of 12 phases**. Pressing **“Esc”** will give you the option to exit and save the brew if you are satisfied with the results.

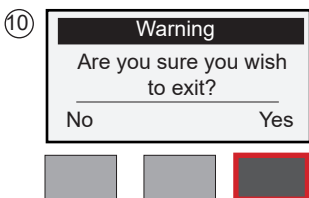

After pressing **“Esc”** the following screen will confirm you want to exit. Pressing **“No”** will bring you back to continue the brew. Pressing **“Yes”** will give you the option to save your brew data.

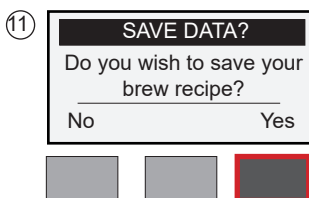

If you do not wish to save your brew recipe, press **“No”**. If you would like to save your brew recipe, select **“Yes”**.

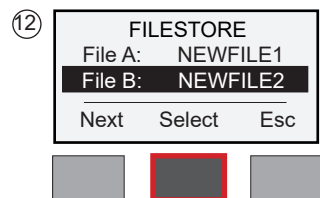

Select the position you wish to save your file in.

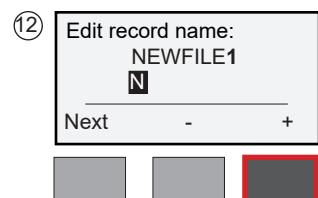

Name the file.

# Accessing Saved Brews

## Method 1: Accessing Saved Preset Brew

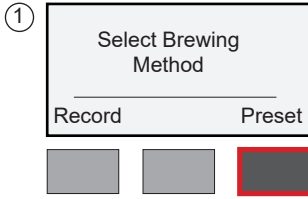

Select "**Preset**" mode.

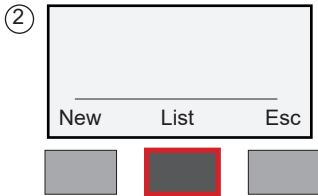

Select "**List**".

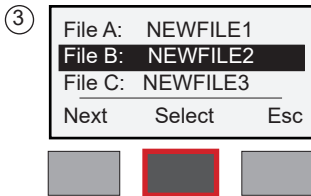

Select the file you want to access.

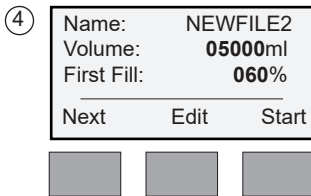

Screen displays the file information.

Pressing "**Start**" will Start the brew  
Pressing "**Edit**" allows you to edit parts of recipe currently on screen  
Pressing "**Next**" brings you to additional brew recipe details.

## Method 1: Accessing Saved Record Brew

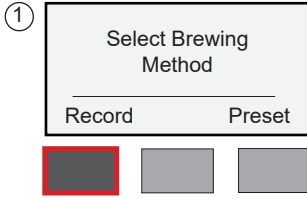

Select **“Record”** mode.

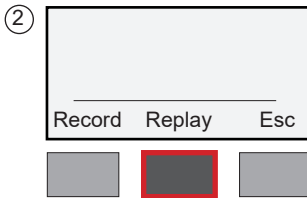

Select **“Replay”** mode.

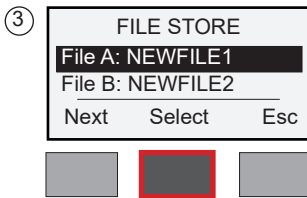

Select the recipe you want to brew..

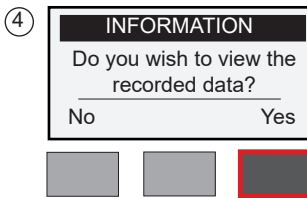

Option will be given to view the selected brew data before beginning brew.  
Pressing **“No”** will skip the brew data and prompt you to start the brew.  
Pressing **“Yes”** will bring you to the brew data.

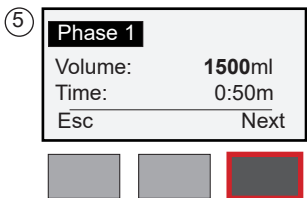

Brew data is displayed.  
Pressing **“Esc”** prompt you to start the brew or exit brew.  
Pressing **“Next”** will bring you to the next page of brew data. Once all brew data has been displayed, pressing **“Next”** will prompt you to start or exit the brew.



# After Brew

1.

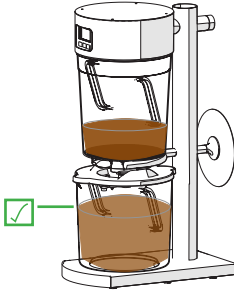

Make sure brew is finished and not just the dispense process. Check container is filled to desired level

2.

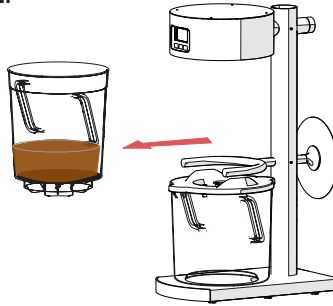

Remove brew chamber

3.



Dump puck

4.

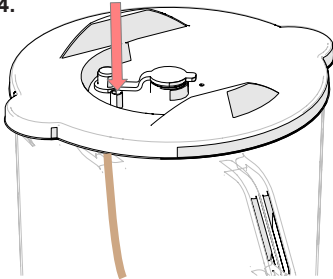

When using with **POUR'D** connect tubing to lid. Ensure bottom tube goes all the way to bottom

5.

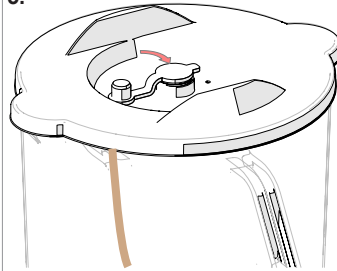

Seal hole for storage

# Cleaning

1.

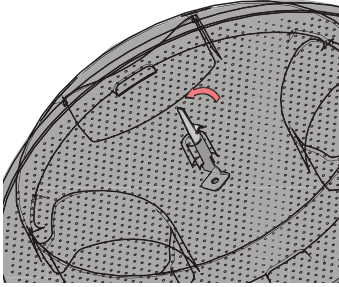

Unclip to remove filter for cleaning

2.

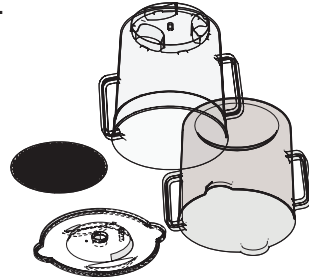

All parts above can be cleaned in a dishwasher

3.

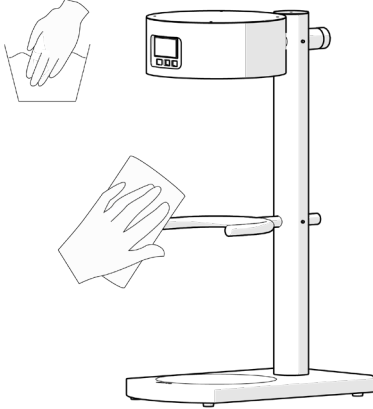

Wipe down body with damp cloth

# Adjust Recipe / Troubleshooting

In presets, go to desired recipe and select 'Edit'

Coffee concentrate is too weak	<ul style="list-style-type: none"><li>• Try a finer grind (this may increase brew time)</li><li>• Lower initial pulse volume</li><li>• Lengthen dispense time</li><li>• Combination of above</li></ul>
Coffee concentrate is too strong	<ul style="list-style-type: none"><li>• Use more water</li><li>• Try a coarser grind (this will also decrease brew time)</li></ul>
Brew time is too slow	<ul style="list-style-type: none"><li>• Try a coarser grind</li><li>• Use more water at the start</li></ul>
Not enough coffee concentrate	<ul style="list-style-type: none"><li>• Use more water</li><li>• If strength is acceptable scale up brew ( increase both amount of grinds and amount of water)</li><li>• Try a coarser grind</li><li>• Leave to drain for longer</li><li>• A variation of above points</li></ul>
Too much coffee concentrate	<ul style="list-style-type: none"><li>• If strength is acceptable scale down brew (decrease both water and ground coffee)</li><li>• If strength is too weak add less water or pull brew early (if yield allows)</li></ul>

Marco Beverage Systems Limited.  
63d Heather Road,  
Sandyford Industrial Estate,  
Dublin 18  
t: +353 (0)1 295 2674  
f: +353 (0)1 295 3715  
e: sales@marco.ie  
www.marco beveragesystems.com

